

使用手册



### ■ 特性:

- 输入范围180~264VAC
- Class II 电源, 无FG
- 内置主动式PFC功能
- 效率高达90.5%
- 空载消耗<0.15W
- 能效等级 VI
- 符合EUErP
- 符合IEC/EN 61558-1,-2-16和IEC/EN 60335-1 (除 OWA-120E-48,54外)家用电器类
- 无风扇设计, 自然风冷
- 保护种类: 短路/过负载/过电压/过温度
- 5年保固

### ■ 应用:

- 机器人割草机
- 家用电器
- 蓄电池充电
- 在多尘或潮湿环境下使用的一般电子产品

### ■ 全球交易品项识别码

MW搜寻: <http://www.meanwell.com.cn/serviceGTIN.aspx>

### ■ 描述:

OWA-120E是一款120W交变直流class II (无接地pin)带防潮功能的外置式电源供应器, 塑胶外壳内部灌满硅胶以提高散热效果, 同时可使OWA-120E达到IP67防水等级, 使该系列成为专门应用于需要防潮,防湿和防尘的外置电源供应器。OWA-120E遵照最新能效要求,空载损耗小于0.15W, 并且通过EN61558-2-16的认证, 而且选定机型更可符合EN60335-1, 可简化如家电类等应用之系统设计。

OWA-120E内建PFC电路, 输入电压范围180VAC~264VAC, 工作效率可高达90.5%, 采用自然风冷, 工作温度范围为-40°C到+70°C。

### ■ 型号编码

**OWA - 120E - 12**

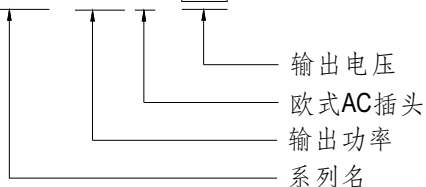



## 120W单组输出防潮型适配器

## OWA-120E系列

## 电气规格

型号	OWA-120E-12	OWA-120E-15	OWA-120E-20	OWA-120E-24	OWA-120E-30	OWA-120E-36	OWA-120E-42	OWA-120E-48	OWA-120E-54	
输出	直流电压	12V	15V	20V	24V	30V	36V	42V	48V	54V
	额定电流	9.6A	8A	6A	5A	4A	3.4A	2.9A	2.5A	2.3A
	额定功率	115.2W	120W	120W	120W	120W	122.4W	121.8W	120W	124.2W
	纹波与噪声(最大)备注2	150mVp-p	150mVp-p	150mVp-p	150mVp-p	200mVp-p	200mVp-p	250mVp-p	250mVp-p	350mVp-p
	电压精度 备注3	±4.0%	±4.0%	±4.0%	±4.0%	±3.0%	±2.0%	±1.0%	±1.0%	±1.0%
	线性调整率	±0.5%	±0.5%	±0.5%	±0.5%	±0.5%	±0.5%	±0.5%	±0.5%	±0.5%
	负载调整率	±2.0%	±1.5%	±1.0%	±0.5%	±0.5%	±0.5%	±0.5%	±0.5%	±0.5%
	启动,上升时间 备注4	500ms, 80m(95%负载) 230VAC								
	保持时间(Typ.)	16ms(满载时) 230VAC								
输入	电压范围	180 ~ 264VAC 254 ~ 370VDC								
	频率范围	47 ~ 63Hz								
	功率因数(Typ.)	PF>0.96/230VAC(满载时)								
	效率(Typ.)	87.5%	89%	90%	90.5%	90%	90%	90.5%	90.5%	90.5%
	交流电流(Typ.)	0.65A / 230VAC								
	浪涌电流(Typ.)	冷启动60A(在50% Ipeak下测试twidth=520μs)/230VAC								
	漏电流	<0.25mA / 240VAC								
保护	过电流	105 ~ 115% 保护模式: 打嗝模式, 负载异常条件移除后可自动恢复								
	短路	打嗝模式, 负载异常条件移除后可自动恢复								
	过电压	15 ~ 17V	17.5 ~ 21V	23 ~ 27V	28 ~ 34V	34 ~ 40V	41 ~ 46V	46 ~ 54V	54 ~ 60V	59 ~ 66V
	过温度	关断输出电压, 重启恢复								
环境	工作温度	-40~+70°C (请参考"减额曲线")								
	工作湿度	20 ~ 95% RH, 无冷凝								
	储存温度、湿度	-40 ~ +80°C, 10 ~ 95% RH								
	温度系数	±0.03% /°C (0~40°C)								
	耐振动	10 ~ 500Hz, 5G 12分钟/周期, X、Y、Z轴各72分钟								
安规和电磁兼容	安全规范	DEKRA EN61558-1,-2-16; DEKRA EN60335-1 (除OWA-120E-48,54外); EAC TP TC 004, IP67 (本体) 认证通过								
	耐压	I/P-O/P:3.75KVAC								
	绝缘阻抗	I/P-O/P:100M Ohms / 500VDC / 25°C / 70% RH								
	电磁兼容发射	符合EN55032 (CISPR32) Class B, EN55014-1, EN61000-3-2,-3; EAC TP TC 020								
	电磁兼容抗扰度	符合EN61000-4-2,3,4,5,6,8,11, EN55014-2, EN55035, 轻工业标准(浪涌L-N: 2KV); EAC TP TC 020								
其它	MTBF	2902.2K hrs min. Telcordia SR-332 (Bellcore)			294.4K hrs min.		MIL-HDBK-217F (25°C)			
	尺寸	191*63*37.5mm								
	包装	1.15Kg; 12pcs/14.8Kg/0.89CUFT								
备注	1. 如未特别说明, 所有规格参数均在输入为230VAC、额定负载、25°C环境温度下进行量测。 2. 纹波和噪声测量方法: 使用一条12"双绞线, 同时终端要并联0.1uf和47uf的电容, 在20MHZ带宽下进行量测。 3. 精度: 包含设定误差、线性调整率和负载调整率。 4. 启动时间是在冷机启动下测得, 频繁的开关机可能使启动时间增长。 ※ 产品免责声明: 详细请参阅 <a href="http://www.meanwell.com.cn/serviceDisclaimer.aspx">http://www.meanwell.com.cn/serviceDisclaimer.aspx</a>									

### ■ 方框图

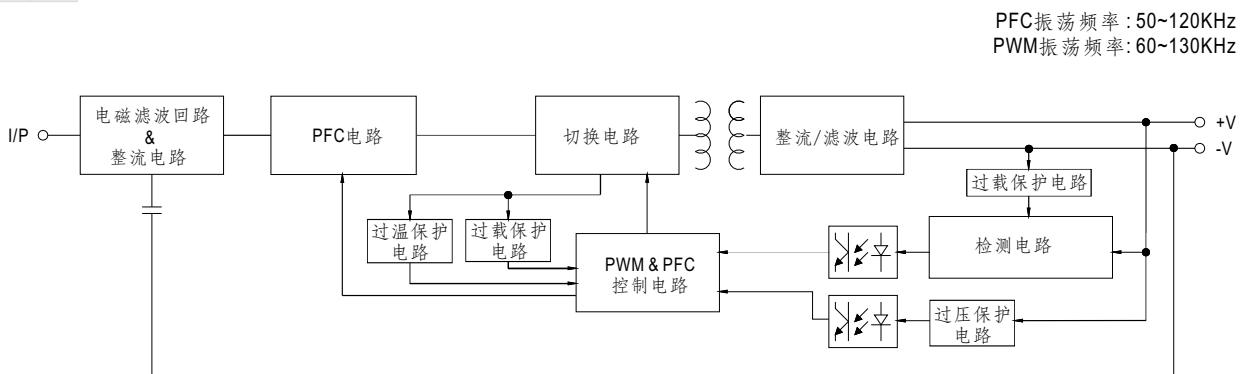

### ■ 减额曲线

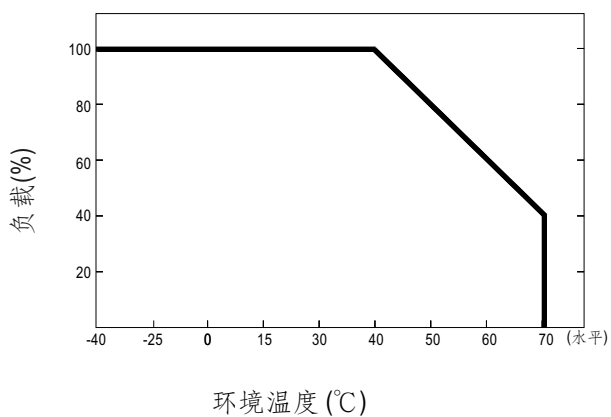

### ■ 静态特性曲线

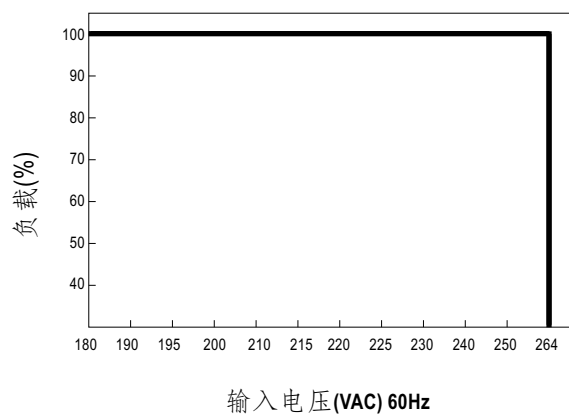

## ■ 机构尺寸

机壳型号: PWM-120 单位:mm

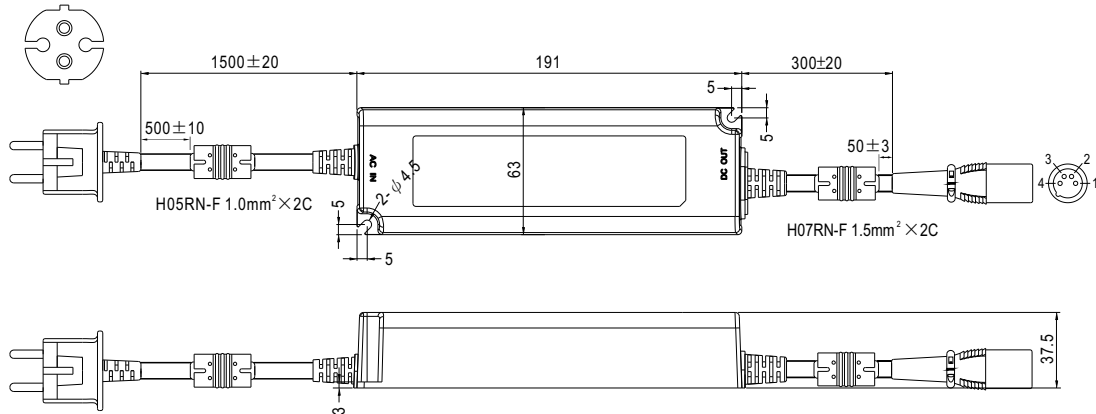





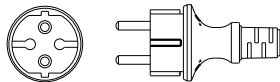



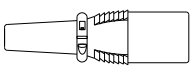

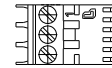

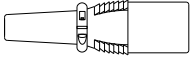

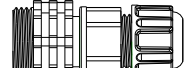

## ■ 输入插头型号

所有标准型: CEE 7/7

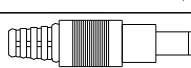

## ■ 输出插头定义

类型	插头描述	插头图	PIN脚号	输出
标准型	XLR 4P, NEUTRIK NC4MX, 或同等品	 	1,2 3,4	+V -V
可选型	Lumberg 3611 03, 或同等品	 	1 2 3	+V floated -V
可选型	XLR 3P, NEUTRIK NC3MX, 或同等品	 	1 2,3	+V -V
可选型	CHOGORI 22002411-01 或同等品	 	1 2	+V -V
可选型	CHOGORI 23002411-01 或同等品	 	1 2	+V -V
可选型	Unicable UT-D170F4-2P 或同等品	 	1 2	+V -V
可选型	Unicable UT-D224-2P 或同等品	 	1 2	+V -V
可选型	2.1φ x 5.5φ x 11 mm, center +, 音叉型	  外侧 ⊖ ⊕ 内侧	CENTER	+V

※详情请联系明纬

## ■ 安装手册

请查阅: <http://www.meanwell.com/manual.html>